



# Interoperabilidad Web de Recursos Académicos

## Conectado silos de información académica abierta a través de Linked Data

**Nelson Piedra | @nopiedra**

**UTPL-> Janneth Chicaiza, Jorge López UPM -> Edmundo Tovar**

14 de marzo, 2014 - México

Día Virtual de Datos Abiertos

@nopiedra #OpenData #OCW #OER #LOCWD #LinkedData #UTPL



CAMPUS  
DE EXCELENCIA  
INTERNACIONAL

**GICAC-UPM**



**Nelson Piedra**

@nopiedra

“@HistoryNeedsYou: The birth certificate of www, from the great @timberners\_lee #web25 pic.twitter.com/KI0051zQmw”  
#SemanticWeb

CERN DD/OC

Information Management: A Proposal

Tim Berners-Lee, CERN/DD

March 1989

Vague but exciting ...

## Information Management: A Proposal

### Abstract

This proposal concerns the management of general information about accelerators and experiments at CERN. It discusses the problems of loss of information about complex evolving systems and derives a solution based on a distributed hypertext system.

Keywords: Hypertext, Computer conferencing, Document retrieval, Information management, Project control

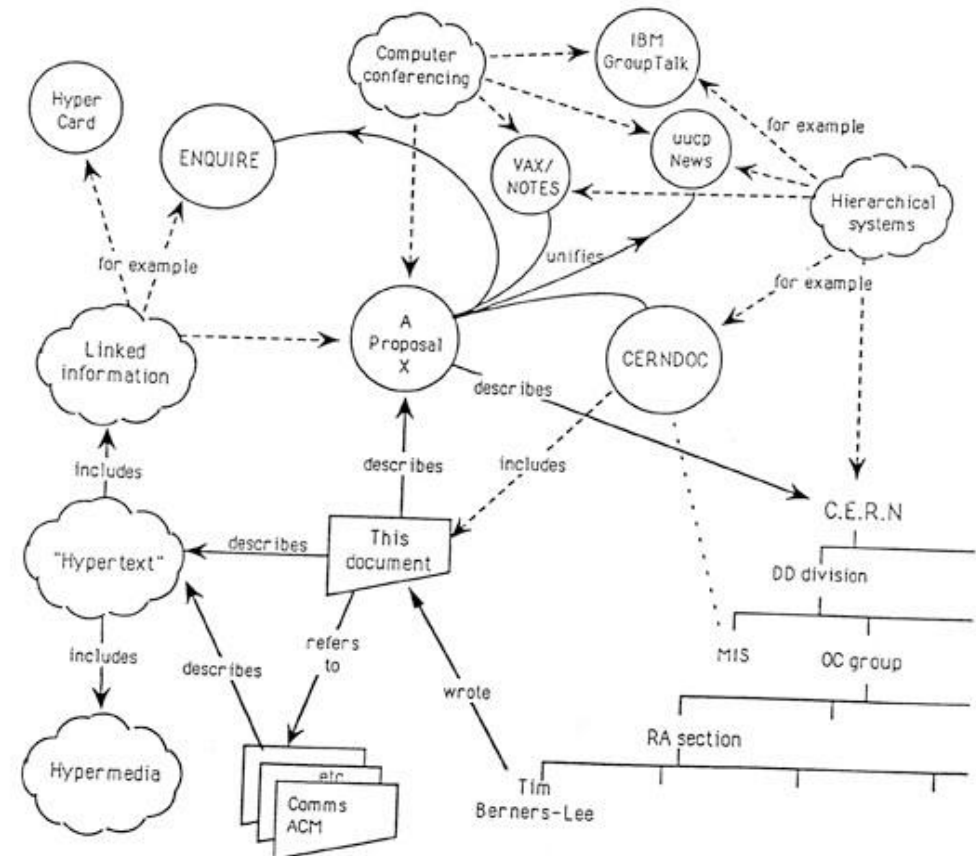

Seguir

**Nelson Piedra**

@nopiedra

#web25

World Wide Web by @timeberners\_lee

@timberners\_lee

#SemanticWeb #WWW #W3C #LinkedData [pic.twitter.com/o1sRNtwwvI](https://pic.twitter.com/o1sRNtwwvI)

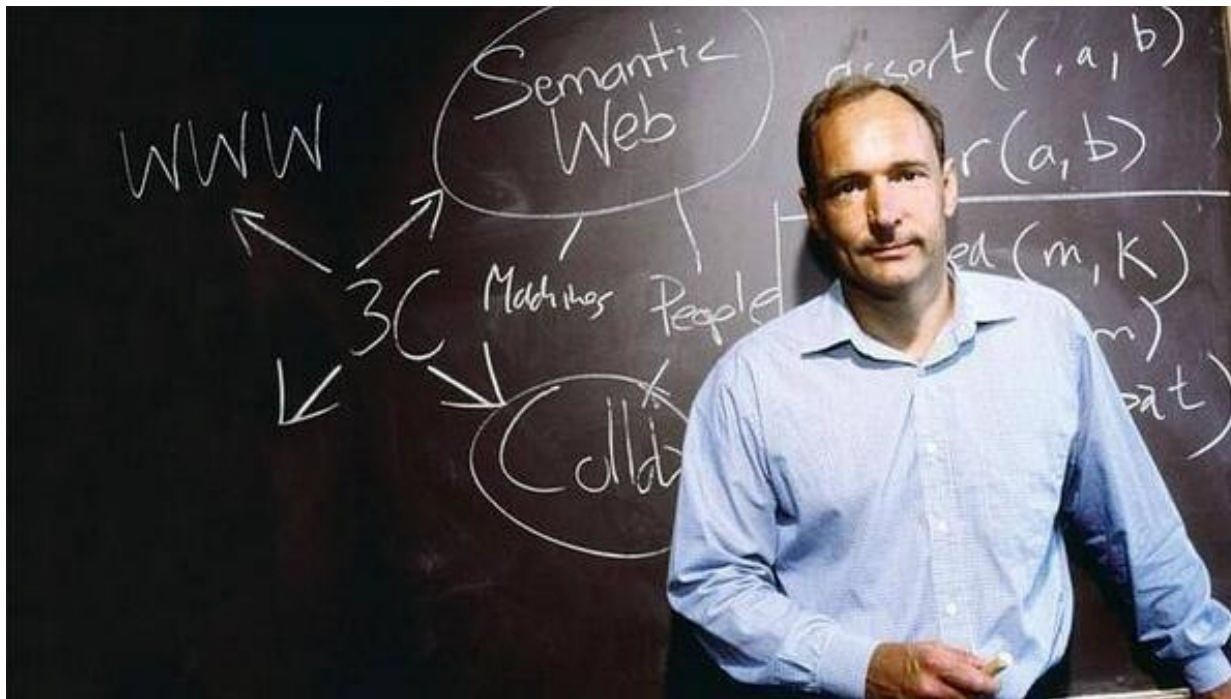

# Linked-Data Principles, back to TBL note from '98

---

Like the web of hypertext, the web of data is constructed with documents on the web. <http://www.w3.org/DesignIssues/LinkedData>

1. **Use URIs to name things on the Web** (for naming everything real or abstract you could think of)
2. Use **HTTP** URIs so that people can look up those names.
3. When someone looks up a URI, provide useful information, using the standards (**RDF\***, **SPARQL**)
4. Include links to other URIs. so that they can discover more things.



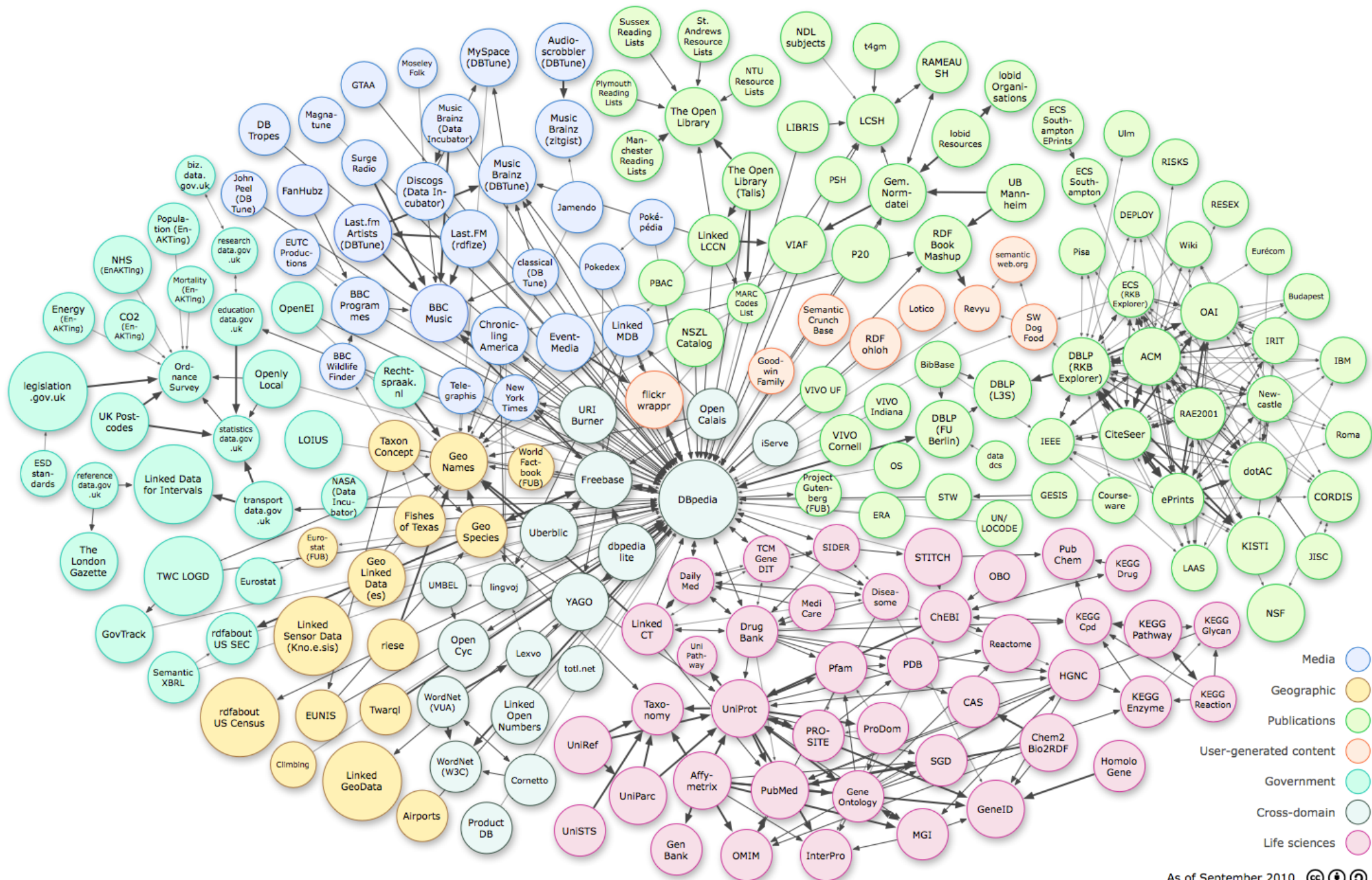

# **BigData - Silos - Smart Data**

La semántica da sentido a los datos

# Linked Data Key Concepts

---

- resource -- an thing of interest (OCW, syllabus, test, lecture, presentation, document, OER, ... )
- URI -- global identifier for a resource. The URIs identify any kind of object or concept.
- representation -- data corresponding to the state of a resource
- information resource -- a “document” containing information
- non-information resource -- anything else
- associated description -- representation describing a Semantic Web resource



# The Resource Description Framework (RDF)

---

- **RDF:** The Resource Description Framework (RDF) is a family of World Wide Web Consortium (W3C) specifications originally designed as a metadata data model. It has come to be used as a general method for conceptual description or modeling of information that is implemented in web resources, using a variety of syntax formats.
- **Resource** - everything with a URI
- **Description** - properties of these resources
- **Framework** - a system to build on
  
- **RDF Schema:**
  - Class (type of resource), Property
  - Sub-Class, Sub-Property
  - Domain and Range





# The RDF Data Model

---

RDF Triples  
Resource Description Framework"

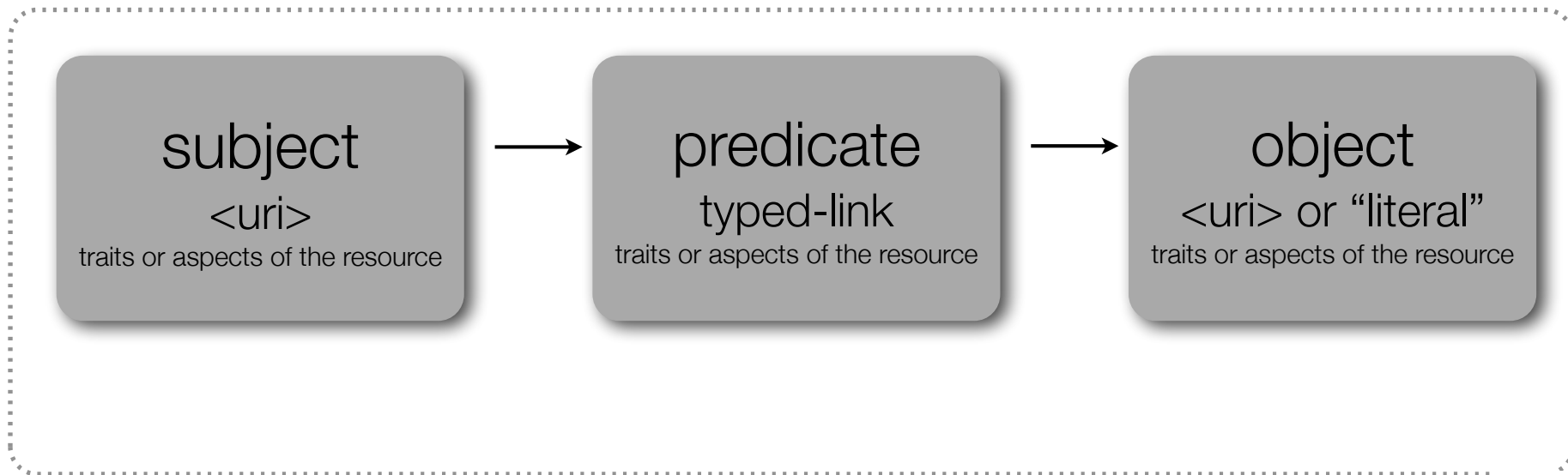

# Linked Data core stack

---

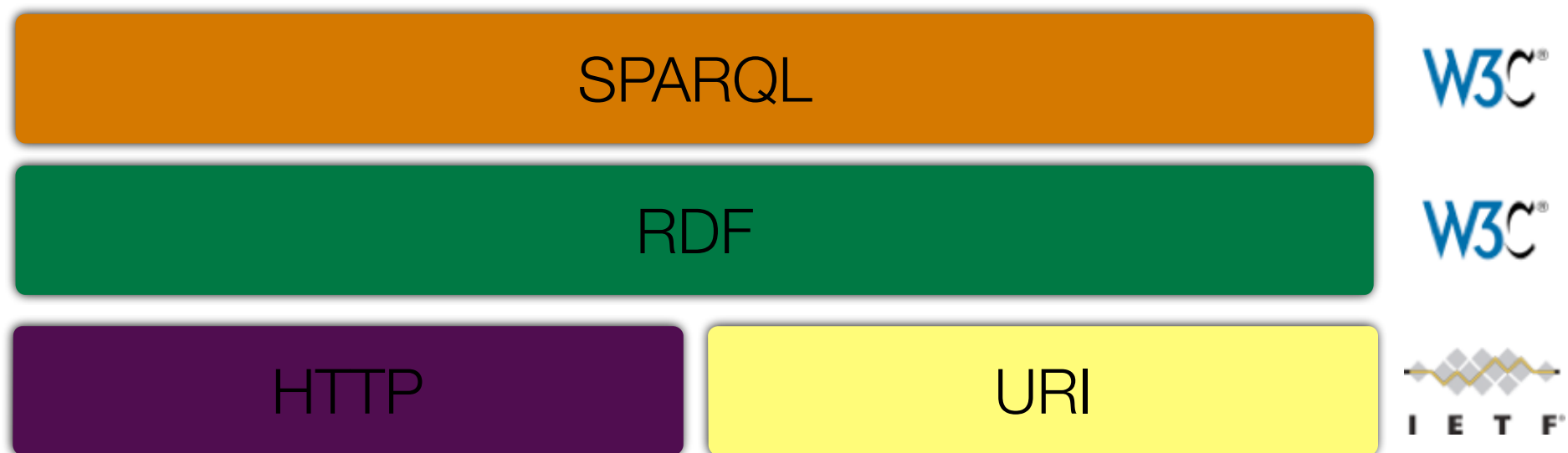

# Linked Data Core Stack, Specifications

---



- [RFC 2616](#) Hypertext Transfer Protocol -- **HTTP**/1.1: Defines HTTP, a generic and stateless application-level protocol for distributed, collaborative, hypermedia information systems.



- [RFC 3986](#) Uniform Resource Identifier (**URI**): Generic Syntax: Defines a generic URI syntax and a process for resolving URI references that might be in relative form, along with guidelines and security considerations for the use of URIs on the Internet.



- [RDF](#) Concepts and Abstract Syntax: Defines the **RDF** graph data model and key concepts.



- [SPARQL](#) Query Language for RDF: Defines defines the syntax and semantics of the **SPARQL** query language for RDF.

# A Best Practice: Linked Open Data star scheme by example

---

Tim Berners-Lee suggested a 5-star deployment scheme for Linked Open Data and Ed Summers provided a [nice rendering](#) of it.

- ★ make your stuff available on the Web (whatever format) under an open license
- ★★ make it available as structured data (e.g., Excel instead of image scan of a table)
- ★★★ use non-proprietary formats (e.g., CSV instead of Excel)
- ★★★★ use URIs to identify things, so that people can point at your stuff
- ★★★★★ link your data to other data to provide context





**Gran cantidad de datos claves  
están distribuidos en la Web**

File:Student using the card catalogue in the library, 1981.jpg

[http://commons.wikimedia.org/wiki/File:Student\\_using\\_the\\_card\\_catalogue\\_in\\_the\\_library,\\_1981.jpg](http://commons.wikimedia.org/wiki/File:Student_using_the_card_catalogue_in_the_library,_1981.jpg)

LIBRARY OF CONGRESS

EBSCO HOST

ISI Web of KNOWLEDGE.

OPEN ACCESS

Google scholar

eprints repository software

SciVerse

Scopus

Digital ARCHIVES

dblp computer science bibliography

amazon.com

The Dataverse Network Project

A Web Application for Publishing, Citing, Analyzing and Preserving Research Data

PubMed

National Library of Medicine NLM

PLoS PUBLIC LIBRARY of SCIENCE

Emerald

EBOOKS



**Extraer**  
(Extract)



**Transformar**  
(Transform)



**Cargar**  
(Load)





## Colaboración Global para acceder a Recursos

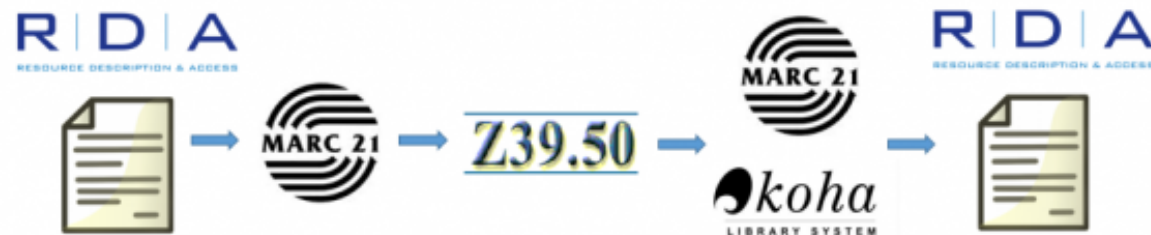

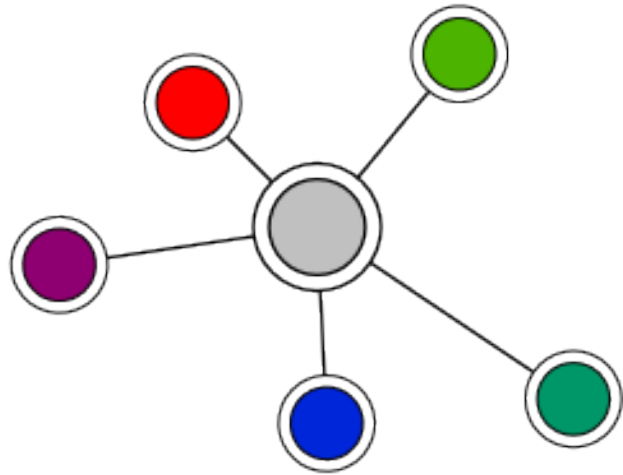

## Ontologías para mejorar la colaboración y descubrimiento Global de recursos bibliográficos

- RDA Ontology
- Dublin Core Ontology
- Bibliographic Ontology (BIBO)
- Citation (CITO)
- Vivo Core Ontology (VIVO)
- Provenance Ontology (PROV-O)
- MODS/MADS
- FRBR
- Holding Ontology





algunos de nuestros  
proyectos en marcha



# **LinkedData + GEO**

# Ecuadorian Geospatial Linked Data

## Abstract

Much of the attention lately has been on geospatial data and their combination with Linked Data. In this paper we present our approach for creating the Ecuadorian Geospatial Linked Data repository, pointing out some existing efforts, and open issues we have to cope with in order to make it easier the publication and exploitation of Geospatial Linked Data.

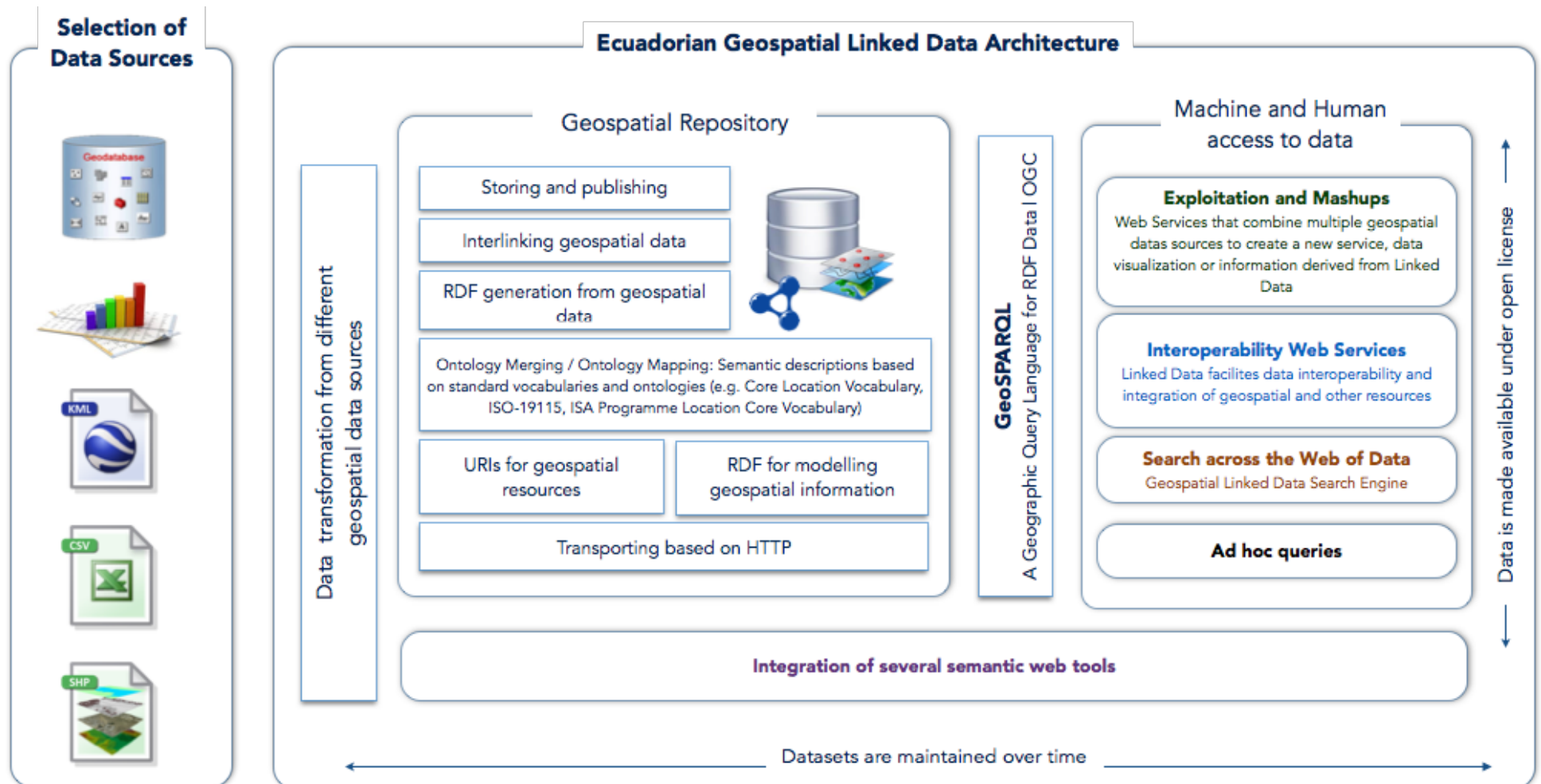



## **LinkedData + Libraries**

# Proyecto: Plataforma de integración, publicación y consulta integrada de Recursos Bibliográficos en la Web semántica.

## Abstract

La presente propuesta de investigación trata el problema de la información bibliográfica y su relación con las tecnologías semánticas. Por medio de estas tecnologías se puede hacer uso de metadatos descritos semánticamente, que permitan un procesamiento basado en conceptos de los objetos descritos. El objetivo general de este proyecto es estudiar métodos y técnicas para la definición de un plan unificado de transformación, publicación, enlace y generación estadística de uso de la información bibliográfica; como también la implementación de una plataforma tecnológica que de soporte a las actividades, utilizando los principios de Linked Data. Es decir, proveer un marco tecnológico y un método para la publicación y enlace de datos bibliográficos. De esta manera, se pretende contribuir al enriquecimiento de la Web de Datos con información bibliográfica recogida en las bibliotecas de la Universidad de Cuenca, Universidad Técnica Particular de Loja (UTPL) y Escuela Politécnica Nacional (EPN), convirtiéndose así en información de referencia.

El desarrollo del proyecto se llevará a cabo en dos etapas: en la primera se realizara el marcado semántico de los recursos bibliográficos y por otra parte se desarrollarán componentes de software capaces de procesar y operar estos recursos a nivel semántico. Sobre este plan de trabajo, el proyecto combina a destacados investigadores ecuatorianos en el campo de la nueva generación de información bibliográfica para abrir el camino en los sectores estratégicos de las bibliotecas hacia la Web 3.0. Por otra parte destacadas universidades invertirán en aplicar los resultados en componentes y estándares que disminuyan la barrera de acceso hacia el mercado de la próxima generación de información bibliográfica en el internet.

Como resultados de este proyecto se pondrán a disposición de la comunidad componentes tecnológicos, procedimientos y estándares para la adquisición, integración, consolidación y explotación de contenidos y servicios de la información bibliográfica. La utilización de los recursos proporcionados por CEDIA permitirá la ejecución óptima de los componentes creados en el proyecto. El proyecto desarrollará un caso de uso en las bibliotecas de la Universidad de Cuenca, UTPL y EPN para validar los resultados de las investigaciones en un entorno real.

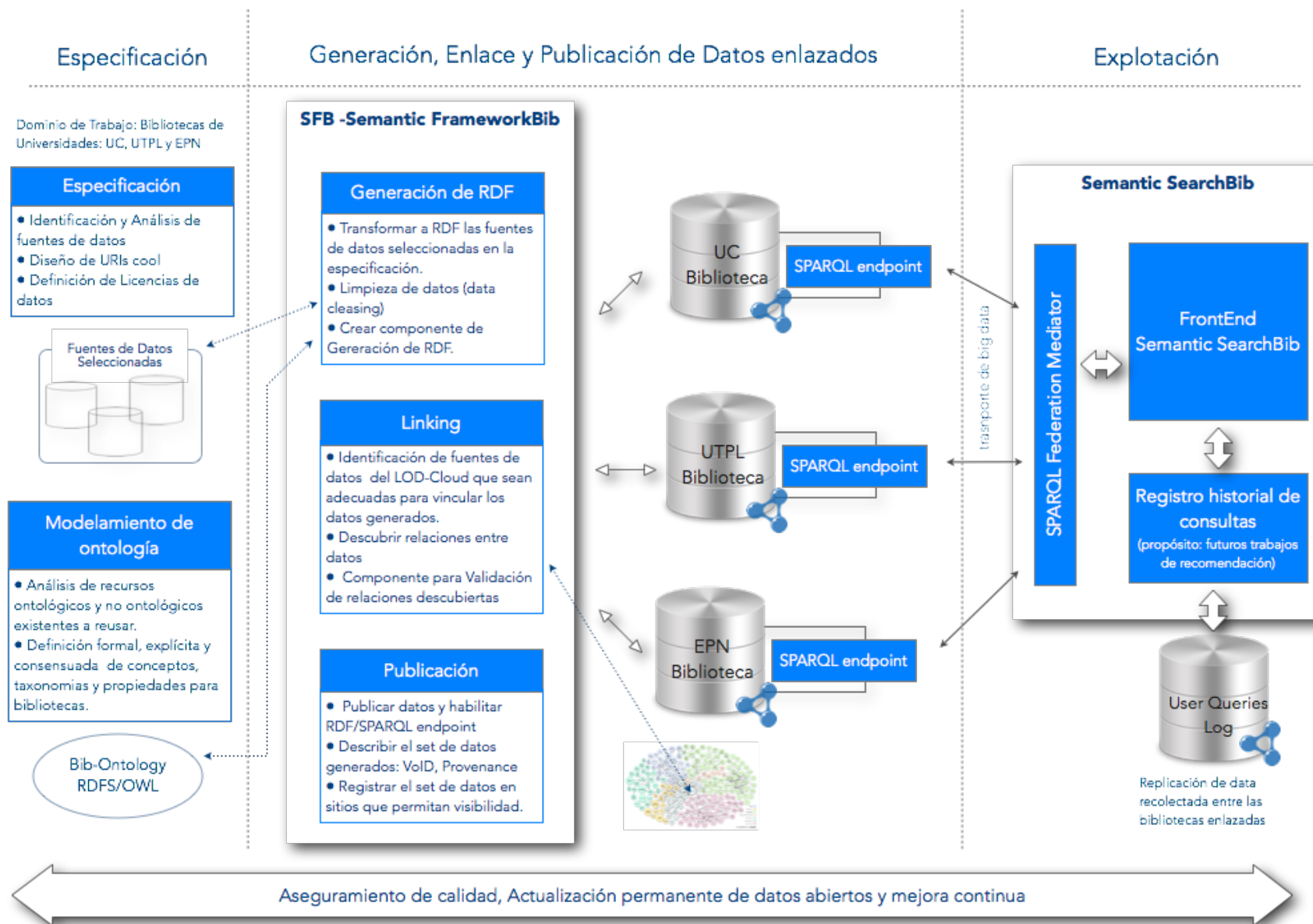



## **LinkedData + Open Educational Resources**

# Consuming and producing linked open data: The case of OpenCourseWare

## Abstract

**Purpose:** The aim of this paper is to present an initiative to apply the principles of Linked Data to enhance the search and discovery of OpenCourseWare (OCW) contents created and shared by the universities. **Design/methodology/approach:** This paper is a case study of how linked data technologies can be applied for the enhancement of open learning contents. **Findings:** Results presented under the umbrella of OCW-Universia consortium, as the integration and access to content from different repositories OCW and the development of a query method to access these data, reveal that linked data would offer a solution to filter and select semantically those open educational contents, and automatically are linked to the linked open data cloud. **Originality/value:** The new OCW-Universia integration with linked data adds new features to the initial framework including improved query mechanisms and interoperability. © Emerald Group Publishing Limited.

Piedra, N., Tovar, E., Colomo-Palacios, R., Lopez-Vargas, J., Chicaiza, J.A.

### **Consuming and producing linked open data: The case of OpenCourseWare**

(2014) *Program* 48 (1) PP. 16 - 40 doi: 10.1108/PROG-07-2012-0045 ISSN: 00330337 Source Type: Journal

DOI: 10.1108/PROG-07-2012-0045 Document Type: Article

Piedra, N., Chicaiza, J., López, J., Tovar, E.

### **Using linked open data to improve the search of open educational resources for engineering students**

(2013) *Proceedings - Frontiers in Education Conference, FIE* PP. 558 - 560

doi: 10.1109/FIE.2013.6684885

Tovar, E., Lopez-Vargas, J.A., Piedra, N.O., Chicaiza, J.A.

### **Impact of open educational resources in higher education institutions in Spain and Latin America through social network analysis**



para recordar,

**Abierto | OPEN:** "A piece of knowledge is open if you are free to use, reuse, and redistribute it"

<http://www.opendefinition.org/okd>

## Motivación: **Descubrimiento y Reuso** de Open Educational Resources...

Un reto para aquellos que están involucrados en proveer y consumir OER/OCW, es disponer de vías que faciliten el descubrimiento de OERs para uso, reuso, adaptación, remezclar y para compartirlos.

**¿Son realmente Abiertos  
los OER?**

**Pensamos que no, que aún  
queda mucho por hacer.**

**Sin embargo, actualmente, en el  
ámbito de OER y OCW:  
El uso de Licencias Abiertas no es  
suficiente!**

Legalmente libre/abierto no implica que sea fácil de descubrir,  
usar, reusar, adaptar, remezclar y compartir.

Uno de los siguientes pasos es **abrir los datos** que están contenidos y aislados en OERs y OCW. Las tecnologías de la **Web Semántica** ofrecen importantes posibilidades para esto

# **Situación actual: OER en silos de datos**

## **Retos en la gestión de información de OER generados y compartidos por organizaciones**

- (1) Estructuras heterogeneas, dependientes de cada proveedor
- (2) Grandes cantidades de datos no estructurados y semi-estructurados.
- (3) No existe semántica compartida.
- (4) Los OERs están almacenados en silos de información, “jardines amurallados”

# raw data within UPM opencourseware web page

The screenshot shows the OpenCourseWare page for 'Ontologies and Semantic Web, 2008'. The page includes a navigation menu on the left, a breadcrumb trail, a search bar, and a main content area with a course description, authors, and a list of master programs. Red arrows point from the right side of the image to specific elements on the page.

**OpenCourseWare**  
Universidad Politécnica de Madrid

Inicio áreas de conocimiento ¿qué es ocw? ocw en la upm

Usted está aquí: Inicio → Ciencia de la Computación e Inteligencia Artificial → Ontologies and Semantic Web

## Ontologies and Semantic Web, 2008

**GUADALUPE AGUADO**  
**OSCAR CORCHO**  
**ASUNCIÓN GÓMEZ**  
Departamento de Inteligencia Artificial.  
Facultad de Informática.

A four-monthly subject in the following official master programs:

- Master in Information Technologies
- European Master in Logic Computation (ERASMUS Mundus Program)
- Master in Research in Artificial Intelligence

**Ontology Network**

Last revision: April 2008.

It is credited 6 ECTS.

Presential classes: 2 hours/week.

Total learning time: 32 hours.

### COURSE HIGHLIGHTS

This course features a complete set of lecture notes. In addition, the coursework section contains the specific assignments for each unit.

Buscar en el Sitio  Buscar

solo en la sección actual

Entrar Spanish

**OCW CONSORTIUM**

**uni>ersia**

**Blog de OCW UPM**

Celebrada en la UPM la reunión de coordinación técnica OCW-Universia

04/04/2011

Se cumplen 10 años de las primeras publicaciones en OCW

17/03/2011

Publicadas 3 nuevas asignaturas

07/03/2011

Más...

**Nuevas Asignaturas!!**

Termoeconomía y Optimización Energética

Estructuras de Datos

**ASIGNATURAS PUBLICADAS.**

OCW University

knowledge area

Title

Author(s)

Department

syllabus

bibliography

year

ects credits

time autoself

description



**‘Ontologies and  
Semantic Web’**



**subject**

has a

**author-creator**



**predicate**

whose name is

**Asunción Gómez  
Pérez**



**object**

<http://ocw.upm.es/ciencia-de-la-computacion-e-inteligencia-artificial/ontologies-and-semantic-web>



**subject**

has a

<http://purl.org/dc/elements/1.1//creator>



**predicate**

whose name is

**Asunción Gómez  
Pérez**



**object**

# example for **locwd** dataset

---

<b>Subject</b>	<b>Predicate</b>	<b>Object</b>
locwd:opencourseware	dc:creator	foaf:Person
locwd:opencourseware	dc:title	xsd:string
locwd:opencourseware	dc:description	xsd:string
locwd:opencourseware	dc:subject	skos:Concept, xsd:string
locwd:biblio	rdfs:subclassOf	bibo:document
locwd:biblio	dcterms:isPartOf, bibo:DocumentPart, dc:title	xsd:string
locwd:ocwRepository	dc:creator	foaf:Organization

# Current situation

OCW environment is a web of documents connected by anchors.  
URLs are used for webpages and anchors.

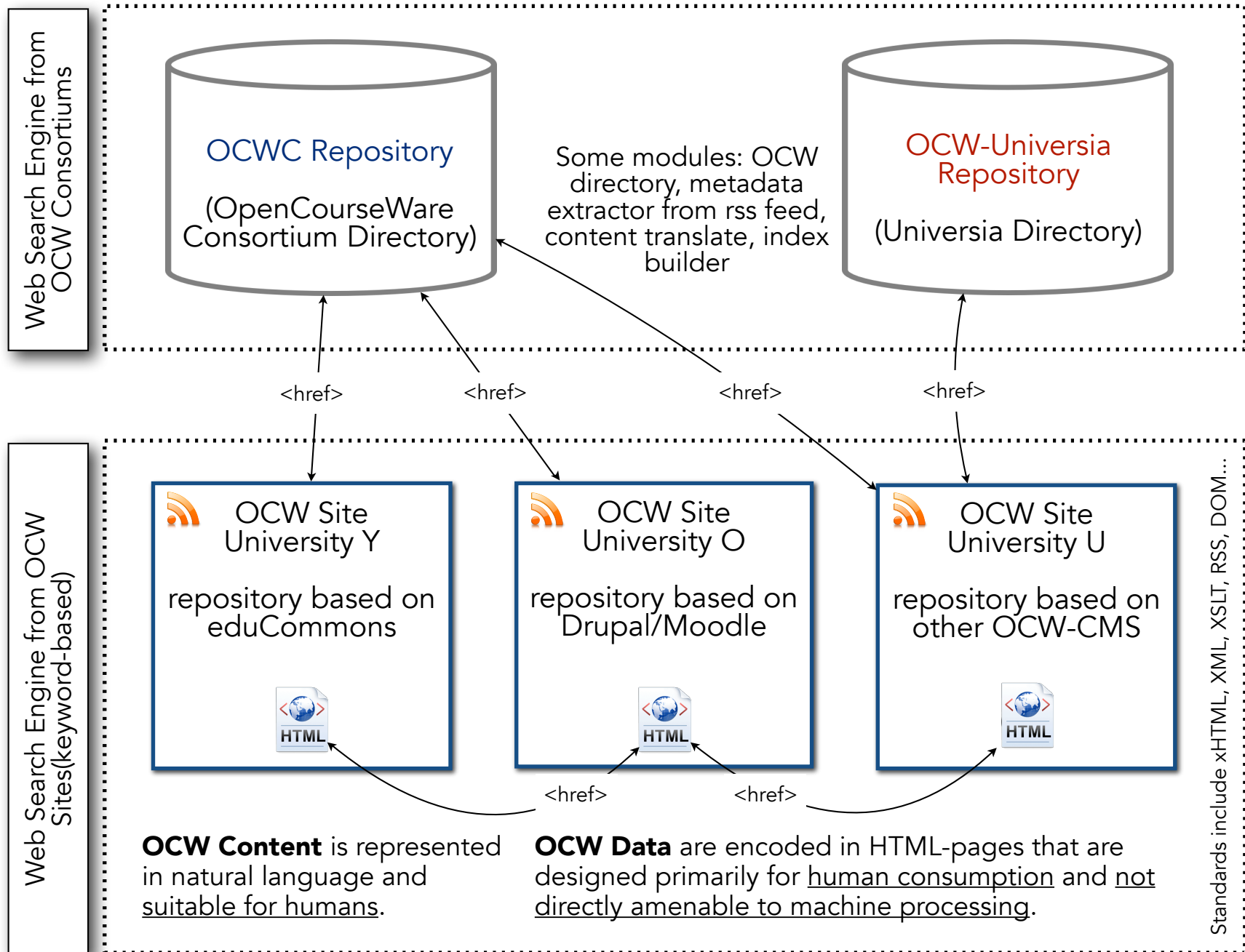

## El Problema:

La presencia de **silos de OER/OCW** **silos** impide la **interoperabilidad**, **descubrimiento**, **síntesis**, y flujos de conocimiento.

Es difícil desarrollar herramientas para consumir datos desde múltiples silos

**Nuestra **visión** sobre  
“OER Openness” es Semántica**

# OER

Educational Content +  
Open Licenses +  
Data in Machine Format

**our semantic vision**

**Educational Content** is for **people**

**Open Linked Data** is for **machines**

# The Technology

**Linked data** have the potential of create bridges between OCW data silos. **RDF** is a way of **recording and sharing** semantic information about resources.



# Why publish Linked OER Data?

- Because LinkedData holds the potential to move our OER collections out of their silos
- Open the data and content silos, to leverage the knowledge capital represented by our OER repositories
- To enrich our information landscape, to improve visibility
- To improve ease of discovery open academic resources
- To improve ease of consumption and reuse of OCW
- To reduce redundancy in searched of OER
- Promoting innovation and Added Value to Open Educational Content

# The value of the **Semantic Web** in **Open Academic Initiatives**

- Semantic Web aid the discovery, reliable re-use of data, provide improved provenance and facilitate automated processing by increased flexibility to changes in presentation and reduced ambiguity.
- Semantic Web technologies can also help to integrate the work of disperse institutions producing diverse data.

i. Select sources of data (information sources)

1 Data source analysis: identify OER providers & select content/resources offered with a free and open license.

Repositories of Open Educational Resources

Open Course Ware  
OCW CONSORTIUM  
OER  
uni>ersia  
API  
Public Domain

- Specification: scope and explicit set of requirements to be satisfied by LOCWD.
- Describe the main technical features of the data selected.

ii. Ontology modelling

2 Concept mapping

3 Vocabulary development (search/reuse ontologies)

4 URI design

LOCWD Common and consensuated ontology  
W3C Semantic Web

base URI: <http://purl.org/locwd/>  
 RDFS: <http://purl.org/locwd/schema#>  
 Resources: <http://purl.org/locwd/resources/>

iii. Generation of RDF resources

5 Content extraction from selected datasources (scraping for non-structured content)

6 Define data patterns for RDF conversion

7 Extractor of data patterns (entity recognition, classification & clustering)

8 Data cleansing (detecting and correcting corrupt or inaccurate data), disambiguation & data reconciliation

raw content  
raw data

iv. Data publication (storage level)

9 Publish extracted data as LinkedData

10 Data enrichment

LOCWD Triple-store  
Linked Open CourseWare DataSet

- URIs for OCW/OER things
- RDF for describe Entities
- Links to other LOD-things

Freebase  
DBpedia  
indice

- Generation of URI Cools
- Create RDF links to resources in the LOD-Cloud)

v. Application Layer

11 Sparql EndPoint

12 OER and OCW Apps based on Linked Data

Faceted data semantic search  
Learning assistant based on OER  
OER discovery tools  
OCW mobile tools  
OCW-nuggets recommender systems (for use, reuse and adaptation of OER)  
OCW-S Builder (MOOCs based on OER)

Linked Open Data

Facilitate finding, retrieving, sharing and adaptation of OER

linked data design issues and data quality assurance

**LOCWD Vocabulary: Linked  
OpenCourseWare Data ontology for  
describe and connect OCW Repositories**

Open Linked Data from Open Educational Content

<http://serendipity.utpl.edu.ec>

# Serendipity

Linked **OpenCourseWare** Data Faceted Search

**Categories**

- Topics (9)
- Tags (20)
- Universities (6)
- Authors (5)
- Languages (2)
- Licenses (3)
- Plataforms (4)
- Consortiums (2)

**Geo**

- Europe (20)
- North America (15)
- Africa (2)

40 results found in 333 ms.

Page 1 of 3 next

## Java Preparation for 6.170

ocw

[More OCW like this](#) |

Published by: [Massachusetts Institute of Technology](#) | Language: [English](#)

Share in:

```
//Option 1
abstract class MadLibEntry {
    /** @return the value of this entry in a template */
    abstract public String templateString();
    /** @return the value of this entry in an actual madlib */
    abstract public String madLibString();
}

/**
 * Collect any relevant information from the user for this entry
 */
abstract public void doLib(UserInterface ui);
}

class TextEntry extends MadLibEntry {
    //What needs to go here?
}

class Slot extends MadLibEntry {
    //What needs to go here?
}

//Option 2
interface class MadLibEntry {
```

This course focuses on introducing the language, libraries, tools and concepts of JavaTM. The course is specifically targeted at students who intend to take 6.170 in the following term and feel they would struggle because they lack the necessary background. Topics include: Object-oriented programming, primitives, arrays, objects, inheritanc

**Author(s):**

- [McCaffrey, Corey](#)
- [Paluska, Justin Mazzola](#)

## Programación en Java I

ocw

[More OCW like this](#) |

Published by: [Universidad Politécnica de Madrid](#) | Language: [Spanish](#)

Share in:



El programa del curso se centra en los fundamentos de la programación en Java, la descripción de sus principales elementos para la programación de ordenadores y una introducción a la metodología de la programación orientada a objetos.

**Author(s):**

- [José María Arranz Santamaría](#)

7239 results found in 67 ms.

Page 1 of 453 next

**Categories**

- ▣ Topics (100)
- ▣ Tags (20)
- ▣ Universities (80)
- ▣ Authors (100)
- ▣ Languages (14)
- ▣ Licenses (20)
- ▣ Plataforms (11)
- ▣ Consortiums (2)

**Geo**

- ▣ North America (2957)
- ▣ Europe (2952)
- ▣ Asia (669)
- ▣ Africa (398)
- ▣ South America (243)
- ▣ Central America (12)

## Dynamics

OCW

More OCW like this |

Published by: [Massachusetts Institute of Technology](#) | Language: English

Share in:

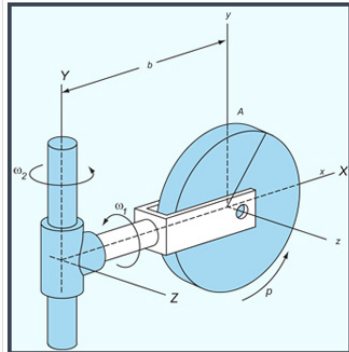

This course covers the fundamentals of Newtonian mechanics, including kinematics, motion relative to accelerated reference frames, work and energy, impulse and momentum, 2D and 3D rigid body dynamics. The course pays special attention to applications in

## Aerodynamics

OCW

More OCW like this |

Published by: [Massachusetts Institute of Technology](#) | Language: English

Share in:



## Administración Estratégica

OCW

Published by: [Universidad Nacional San Agustín](#) | Language: Spanish

Share in:



El curso permite conocer las herramientas estratégicas, que permitan realizar una administración, basada en la planificación. Las organizaciones inteligentes deben reivindicar con mayor fuerza la importancia de su planificación estratégica y la prospectiva estratégica, para asegurar la toma de decisiones que les asegure un mejor porvenir.

Author(s):

- Dr.Horacio Barreda Tamayo

Tag(s):

**Ingenierías**

Similar courses









- [MT00851: Administración de ventas \(Tecnológico de Monterrey Open Courseware\)](#)  
Description: Este curso está diseñado para que comprendas los conceptos de la administración de ventas y la forma de aplicarlos para resolver problemas de negocios. Como la mayoría de ustedes pueden iniciar sus actividades como vendedores, necesitan entender el papel del gerente de ventas a fin de funcionar mejor en sus puestos y prepararse a sí mismos para su primera oportunidad de ascenso. Al participar activamente en este proceso, desarrollarás las habilidades de capacidad de búsqueda, análisis de la información y la toma de decisiones, la relación...
- [GA5077: Seminario integrador \(Tecnológico de Monterrey Open Courseware\)](#)  
Description: El espíritu del Seminario es integrar las habilidades de liderazgo y competencia técnica del ejecutivo actual para que se propongan ideas innovadoras, creativas y adecuadas a las situaciones que se viven diariamente en las empresas y organizaciones del mundo globalizado. El curso incentiva a desarrollar una visión holística de las empresas y promueve, de manera dinámica y participativa, la incorporación en la toma de decisiones de los aspectos científicos, humanos y estratégicos que el alumno ya ha desarrollado a través de su programa de posgrado que culmina con este último curso.
- [Marketing del Deporte](#)  
Description: conocimientos de Dirección de Marketing que, partiendo de un nivel básico, permitan la aplicación de conceptos, técnicas y herramientas que faciliten, en el contexto de la gestión deportiva, la comprensión de la función comercial y la toma de decisiones en este ámbito





# Principles of Optimal Control

## Course description

More OCW like this |  | Share in:       

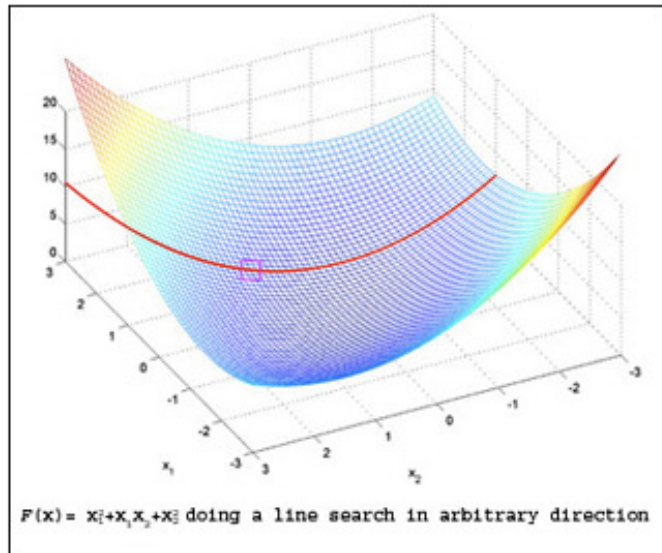

Published by: [Massachusetts Institute of Technology](#) | Language: [English](#) | Source: <http://ocw.mit.edu/courses/aeronautics-and-astronautics/16-323-principles-of-optimal-control-spring-2008>

★ ★ ★ ☆ ☆ 1 vote, 3.00 avg. rating

 Like this 1 like  0 dislikes

control x add a tag



## **LinkedData + Recomendación de OERs**

Tecnologías de la Web Semántica y Social Network Analysis

# Recomendación de OER

Piloto: formación de emprendedores

## Entrepreneur Context - Training based on OER

Interaction between User Profile, Learning Paths and OER



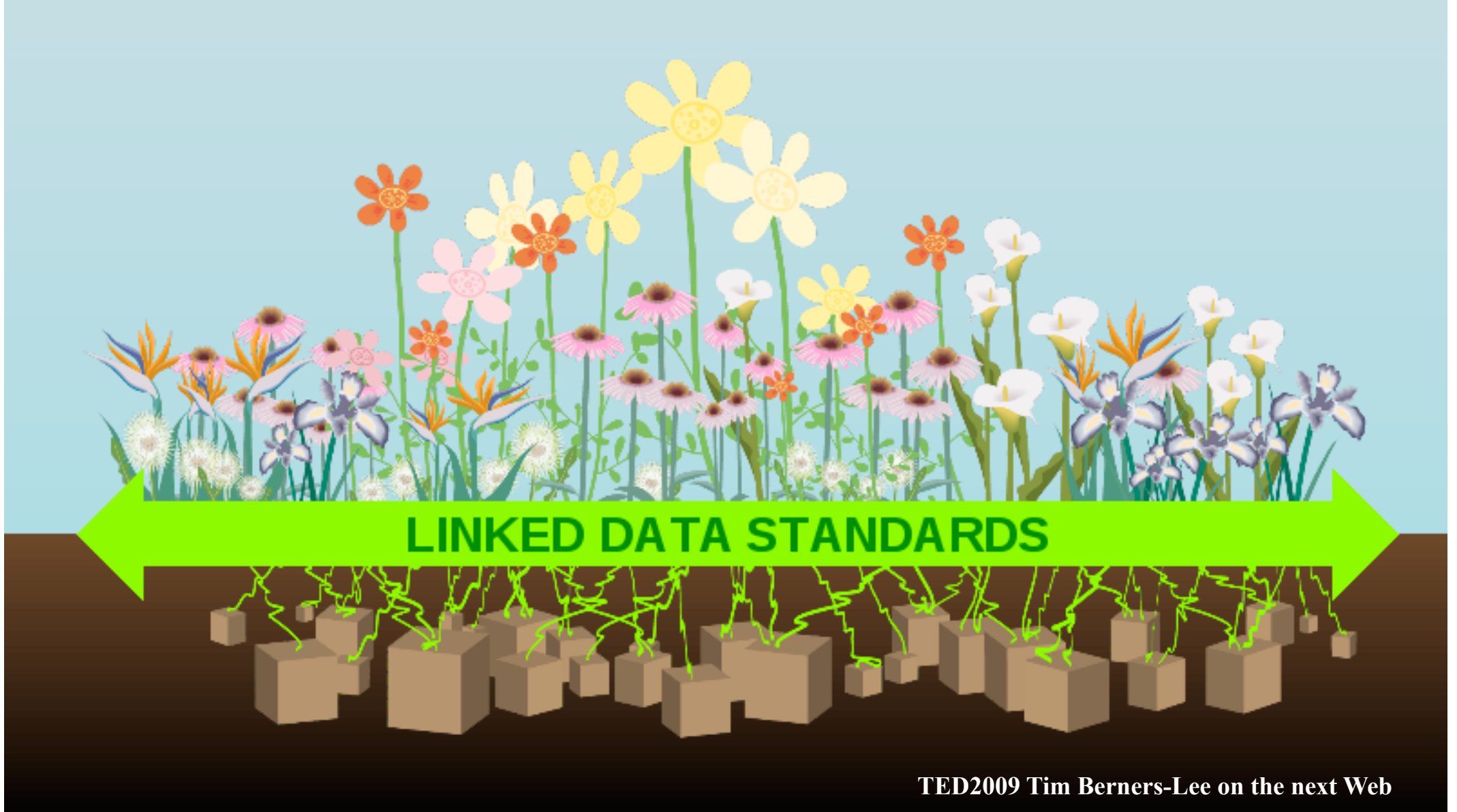

TED2009 Tim Berners-Lee on the next Web

Linked Data es Interoperabilidad de Data

La necesidad de comunicación e interoperación entre sistemas de información distribuidos y autónomos se ha incrementado con el uso de la Web.

**e.g. Interoperabilidad entre Repositorios OCW/OER heterogéneos y distribuidos**

**raw data now!**

# Conclusión: el futuro de integración e interoperabilidad de información es de datos enlazados

- Colaboración
- Descentralización
- Localización
- Enriquecimiento semántico
- Datos estructurados
- Integración
- Interoperabilidad

# Datos Abiertos



Día Virtual de la Comunidad de Bibliotecas Digitales

Transmisión en vivo | Videoconferencia

*gracias!*

@nopiedra  
[nopiedra@utpl.edu.ec](mailto:nopiedra@utpl.edu.ec)



CAMPUS  
DE EXCELENCIA  
INTERNACIONAL

GICAC-UPM

